



Making Recreation Easy!



***RV
Accessories
Catalog***



TABLE OF CONTENTS

TABLE OF CONTENTS	1
2000/2001 VALTERRA NEW PRODUCTS	2
2000/2001 NEW PRODUCTS	3
2000/2001 NEW PRODUCTS	4
2000/2001 NEW PRODUCTS	5
2000/2001 NEW PRODUCTS	6
BLADEX™ WASTE VALVES	7
BLADEX™ WASTE VALVES	8
FLANGED VALVE FITTINGS	9
FLANGED VALVE FITTINGS & ASSEMBLIES	10
CAPS, HOSE ADAPTERS & ACCESSORIES	11
RV BATHROOM & KITCHEN FIXTURES	12
PLUMBING FITTINGS & ACCESSORIES	13
Potty Toddy Tabs	14
TANK FLUSHING PRODUCTS	15
TANK CLEANING PRODUCTS	16
VALTERRA SEWER DRAIN HOSES	17
SEMI-RIGID SEWER HOSE	18
DRAIN HOSE ACCESSORY	18
E-Z HOSE CARRIERS	18
EZ COUPLER DRAIN HOSE FITTINGS	19
EZ COUPLER DRAIN HOSE FITTINGS	20
THE "QUICK CONNECT" SEWER HOSE SYSTEM	21
SEWER INLET/DRAIN HOSE FITTINGS	22
FRESH WATER HOSES	23
PLASTIC BARBED FITTINGS	24
FRESH WATER TANKS	25
FRESH WATER ACCESSORIES	26
RVing BOOKLETS	27
FRESH WATER ACCESSORIES	27
RV SPECIALTY PARTS	28
AWNING TIE-DOWNS	29
REFRIGERATOR FANS	30
KITCHEN ACCESSORIES	31
KITCHEN ACCESSORIES	32
UNIVERSAL DOOR LOCKS	33
DEADBOLTS, LATCHES, & REPLACEMENTS	34
Literature Request Form	35
LIMITED ONE YEAR WARRANTY	36

Part No.

Ctn.Qty.

Ctn.Wt.

Retail Price



RV Accessory Starter Kits

Available in 12 different product combinations, and packaged in an attractive 4-color box, makes each kit an outstanding impression. Whether purchased retail or given free, compliments of the dealer, each kit will make a favorable impact creating the potential for repeat business. The front flap of the box has a place for the dealer to insert a business card.



Basic Starter Kits

K88101	Basic RV Accessory Starter Kit w/Potty Toddy	22.95
---------------	---	--------------

- One Roll Toilet paper
- One 15' drinking water hose
- One 30/15 amp electrical adapter
- One Potty Toddy card of 2 tabs
- One 10' drain hose with straight hose adapter
- Two disposable RV dump gloves

K88102	Basic RV Accessory Starter Kit w/RV Trine	24.10
---------------	--	--------------

- One Roll Toilet paper
- One 15' drinking water hose
- One 30/15 amp electrical adapter
- Two 2 oz dry RV Trine
- One 10' drain hose with straight hose adapter
- Two disposable RV dump gloves

K88103	Basic RV Accessory Starter Kit w/Aqua Kem	28.03
---------------	--	--------------

- One Roll Toilet paper
- One 15' drinking water hose
- One 30/15 amp electrical adapter
- Two 2 oz dry Aqua Kem
- One 10' drain hose with straight hose adapter
- Two disposable RV dump gloves



Standard Starter Kits

K88104	Standard RV Accessory Starter Kit w/Potty Toddy	24.95
---------------	--	--------------

- One Roll Toilet paper
- One 25' drinking water hose
- One 30/15 amp electrical adapter
- One Potty Toddy card of 2 tabs
- One 10' drain hose with straight hose adapter
- Two disposable RV dump gloves

K88105	Standard RV Accessory Starter Kit w/RV Trine	26.10
---------------	---	--------------

- One Roll Toilet paper
- One 25' drinking water hose
- One 30/15 amp electrical adapter
- Two 2 oz dry RV Trine
- One 10' drain hose with straight hose adapter
- Two disposable RV dump gloves

K88106	Standard RV Accessory Starter Kit w/Aqua Kem	30.03
---------------	---	--------------

- One Roll Toilet paper
- One 25' drinking water hose
- One 30/15 amp electrical adapter
- Two 2 oz dry Aqua Kem
- One 10' drain hose with straight hose adapter
- Two disposable RV dump gloves

Part No.

Ctn.Qty.

Ctn.Wt.

Retail Price

RV Accessory Starter Kits

Deluxe Starter Kits



K88107 Deluxe RV Accessory Starter Kit w/Potty Toddy 42.87

- One 4 Pk Toilet paper
- One 25' drinking water hose
- One 30/15 amp electrical adapter
- One Water Regulator
- Two Potty Toddy cards of 2 tabs
- One 10' drain hose with straight hose adapter
- One Bubble Level
- One bag of disposable RV dump gloves



K88108 Deluxe RV Accessory Starter Kit w/RV Trine 45.17

- One 4 Pk Toilet paper
- One 25' drinking water hose
- One 30/15 amp electrical adapter
- One Water Regulator
- Four 2 oz dry RV Trine
- One 10' drain hose with straight hose adapter
- One Bubble Level
- One bag of disposable RV dump gloves



K88109 Deluxe RV Accessory Starter Kit w/Aqua Kem 57.07

- One 4 Pk Toilet paper
- One 25' drinking water hose
- One 30/15 amp electrical adapter
- One Water Regulator
- Four 2 oz dry Aqua Kem
- One 10' drain hose with straight hose adapter
- One Bubble Level
- One bag of disposable RV dump gloves



Premium Starter Kits

K88110 Premium RV Accessory Starter Kit w/Potty Toddy 55.37

- One 4 Pk Toilet paper
- One 25' drinking water hose
- One 30/15 amp electrical adapter
- One Water Regulator
- One Drinking Water Freshener
- One Potty Toddy card of 6 tabs
- One 10' drain hose with speedi adapter kit
- One Bubble Level
- One bag of disposable RV dump gloves



K88111 Premium RV Accessory Starter Kit w/RV Trine 58.90

- One 4 Pk Toilet paper
- One 25' drinking water hose
- One 30/15 amp electrical adapter
- One Water Regulator
- One Drinking Water Freshener
- Six 2 oz dry RV Trine
- One 10' drain hose with speedi adapter kit
- One Bubble Level
- One bag of disposable RV dump gloves



K88112 Premium RV Accessory Starter Kit w/Aqua Kem 72.25

- One 4 Pk Toilet paper
- One 25' drinking water hose
- One 30/15 amp electrical adapter
- One Water Regulator
- One Drinking Water Freshener
- Six 2 oz dry Aqua Kem
- One 10' drain hose with speedi adapter kit
- One Bubble Level
- One bag of disposable RV dump gloves



Part No.

Ctn.Qty.

Ctn.Wt.

Retail Price



RV Trine Enzyme Toilet Treatments

RV Trine toilet deodorizer and waste digester is a powerful all natural enzyme formulation.

- Eliminates odors/fresh lemon scent
- Enhances all septic systems
- Formaldehyde free
- Digests waste and all toilet papers
- Cleans tank probes/sensors & lubricates valves
- Environmentally safe waste digester

V88309	RV-Trine Dry, 8-2 Oz Packs	16	21	10.98
V88359	RV-Trine Liquid, 8 Oz Bottle	12	8	8.75
V88369	RV-Trine Liquid, 16 Oz Bottle	12	15	12.48
V88379	RV-Trine Liquid, 32 Oz Bottle	12	30	17.18



Holding Tank Conditioner

This unique conditioner accomplishes by itself what other brands do with many products. Use as a one time treatment to keep holding tanks in top working condition.

- Works in both black and gray tanks
- Cleans probes and valves
- Lubricates drain valves
- Digests toilet paper
- Eliminates clogged drain pipes
- Formaldehyde -free and environmentally-safe
- Great for winter storage

V88439	Holding Tank Conditioner, 32 Oz Bottle	12	29	8.28
--------	--	----	----	------



Toilet Bowl and Bathroom Cleaner

Works without scrubbing, removes oily grime and scale build-up from toilets, sinks, bathrooms, walls and floors without scratching surfaces or counteracting other holding tank chemicals. Can be used safely on porcelain, plastic, steel, tile, vinyl, acrylic or fiberglass

- Removes scale, stains and mildew
- Safe on all surfaces - non abrasive
- Fresh lemon scent
- Controls musty odors
- Will not stain
- Will not harm seals or plastic parts
- Non-toxic

V88719	Toilet Bowl & Bathroom Cleaner, 16 Oz Bottle	12	15	4.55
--------	--	----	----	------



Instant Deodorizer for Holding Tanks

Instantly freshens, cleans and deodorizes holding tank systems for safe and effective odor control, Its all weather formula makes it the perfect companion all year round.

- Works in gray and portable tanks
- Freshens with lemon scent
- No pre-cleaning necessary
- Will not stain or damage seals
- Safe to use in portable and recirculatory toilets
- Effective at all temperatures
- Non-toxic, biodegradable and formaldehyde-free
- Accepted at all dump stations

V88419	Instant Deodorizer, 32 Oz Bottle	12	29	9.48
--------	----------------------------------	----	----	------



Drinking Water Freshener

This concentrated formula works fast to eliminate tastes and odors associated with anti-freeze, chlorine, plastic and metal tanks, or just about anything that leaves water stale or musty

- 1/2 ounce treats 20 gallons
- No waiting—works in minutes
- Chlorine-free
- No pre-cleaning or rinsing necessary
- Use in refrigerators, trash cans and coolers to stop odors
- Non-toxic and environmentally-safe

V88459	Drinking Water Freshener, 8 Oz Bottle	12	7	5.98
--------	---------------------------------------	----	---	------

Part No. **Ctn.Qty.** **Ctn.Wt.** **Retail Price**



Hose Savers

- Prevents hose from crimping or pinching
- Works for RV's or homes
- EZ Hose gripper pre-assembled for ease of use

A01-0117VP	90° Hose Saver, Plastic, Carded	50	8	4.53
A01-0118VP	45° Hose Saver, Brass, Carded	50	12	5.55
A01-0119VP	90° Hose Saver, Brass, Carded	50	12	5.25



Water Regulator

- Protects your RV's plumbing system against extreme high pressures
- Outlet pressure factory set at 45 psi
- Fits all standard water hose and campground water risers
- Includes easy to use hose gripper

A01-1115	Water Regulator, Bulk	30	14	8.80
A01-1115VP	Water Regulator, Carded	48	22	9.30



Electrical Adapter

A10-0014	30/15 amp Electrical Adapter	1/500	71	2.62
----------	------------------------------	-------	----	------



WINTERIZING PRODUCTS

Blow Out Plug

Blow out excess water from fresh water plumbing before winterizing.

P23500VP	RV Blow Out Plug	50	3	2.30
----------	------------------	----	---	------

By-Pass Kits

- Four different ways to save 6-10 gallons of anti freeze each year by-passing the water heater in your RV.
- Permanent kits allow quick and easy winterizing year after year.
- EZ turn kit provides for a simple single, manual valve, method of bypassing the water heater.

P23502VP	RV Seasonal By-Pass Kit	20	19	7.38
P23503VP	6 Gallon By-Pass Kit	24	26	25.50
P23504VP	10 Gallon By-Pass Kit	24	27	25.50
P23505VP	EZ Turn By-Pass Kit	24	26	26.97

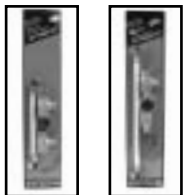
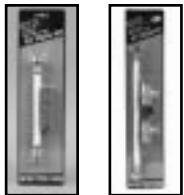

Pump Converter Kit

This kit allows you to quickly and easily fill your water lines with non-toxic antifreeze, leaving your water system fully protected from freezing temperatures. You will save a minimum of 6 gallons of non-toxic antifreeze each time the RV is winterized.

P23506VP	Pump Converter Kit			18.15
----------	--------------------	--	--	-------

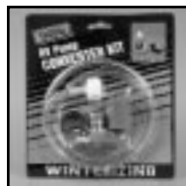

Part No		Ctn.Qty.	Ctn.Wt.	Retail Price
---------	--	----------	---------	--------------



EZ Coupler Drain Hose

Premium duty 18 mil vinyl material over wire to ensure superior performance and long life.

- Top-of-the-line hose has UV protected material
- Right-hand coiling is totally compatible with EZ Coupler fittings
- Prevents difficult cross threading on left hand coiled hose



D04-0104	12' EZ Coupler Drain Hose	6	21	14.83
D04-0106	10' EZ Coupler Drain Hose Kit	4	18	32.38



RV Dump Gloves

Disposable gloves keep hands clean when dealing with your plumbing system. One size fits all. High-density polyethylene disposable gloves.

D04-0108	RV Dump Gloves, 12 per bag	150	7	2.00
----------	----------------------------	-----	---	------



Toilet Paper

Quilted for luxurious softness. Safe for all portable toilets, RV, Marine and septic systems. Breaks up quickly in your waste holding tank.

Q23630	2 ply 4-pack, 280 Sheets	24	23	2.75
Q23632	2 ply single roll, 500 sheets	96	25	1.23



Universal Mount Fridge Vent Exhaust Fan

- "Wind Tunnel" design increases refrigerator cooling efficiency up to 40%
- Fully automatic, only activates when fridge is on.
- Turns itself on at 110°, off at 90°
- Can be mounted at the top of fridge rear compartment, or on the back of the refrigerator to blow air over the coils.

A10-2618VP	Universal Mount Fridge Fan	12	10	37.56
------------	----------------------------	----	----	-------



Bubble Level

- Small and compact
- Easy to stick on
- Level three ways: horizontal, vertical and surface

B2402	Bubble Level	100	25	3.05
-------	--------------	-----	----	------



Wheel Chock

Prevents tires from rolling and sliding. Has rubber surface for better grip, and nylon cord to easily remove the chock when finished.

A10-0908	Wheel Chock, Red	14	10	4.35
----------	------------------	----	----	------



BLADEx™ WASTE VALVES

Part No.

Ctn.Qty.

Ctn.Wt.

Retail Price

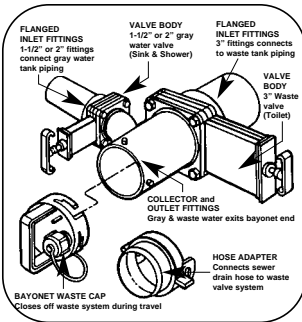

Bladex™ Waste Valves

- The easiest valves on the market to open and close
- All handles are threaded for easy replacement
- Seals are made of high quality Santoprene for chemical resistance and maximum durability
- Bladex™ valves are interchangeable with Valterra, Grentec, Anonda, Larden, and Bristol brands
- Bladex™ “The Valves of the Future”

Bladex™ Waste Valves with Plastic Handles

T1001VP	1-1/2" Bladex™ Waste Valve Body, Carded Black w/gate seals, nuts, bolts	50	24	8.88
T1001DSPB	Same as Above, Black - Drilled Stem No Handle	1	-	8.88
T1002VP	2" Bladex™ Waste Valve Body, Carded Black w/gate seals, nuts, bolts	40	22	10.04
T1003VP	3" Bladex™ Waste Valve Body, Carded Black w/gate seals, nuts, bolts	38	32	10.68
T1003DSPB	Same as Above, Black - Drilled Stem No Handle	1	-	10.68



Bladex™ Valves with Metal Handles

Bladex™ waste valves come with durable, die-cast aluminum handles. Aluminum handles offer reliable strength that you can trust.

T1001VPM	1-1/2" Bladex™ Waste Valve w/Metal Handle, Carded - Black w/gate seals, nuts, bolts	50	26	10.48
T1002VPM	2" Bladex™ Waste Valve w/Metal Handle, Black - carded w/gate seals, nuts, bolts	40	24	11.46
T1003VPM	3" Bladex™ Waste Valve w/Metal Handle, Black - carded w/gate seals, nuts, bolts	38	33	12.31



Bladex™ Valve Replacement Seals

Bladex™ seals are specially designed to eliminate leaks, gate seal pinching, and misalignment during movement of rotating valve fittings. Seals are made of high-quality Santoprene for chemical resistance and maximum durability. Bladex™ seals are the only recommended replacement seals for the Bladex™ line of waste valves. Look for the distinctive Bladex™ package.

T1001-7N	1-1/2" Bladex™ Replacement Seal, Bulk	50	1	.93
T1001-9VP	Two Bladex™ 1-1/2" Seals, Carded W/Nuts, Bolts	40	6	3.19
T1002-7N	2" Bladex™ Replacement Seal, Bulk	50	1	1.13
T1002-9VP	Two Bladex™ 2" Seals, Carded, W/nuts,bolts	40	6	3.61
T1003-7N	3" Bladex™ Replacement Seal, Bulk	50	2	1.38
T1003-9VP	Two Bladex™ 3" Seals, Carded, W/nuts,bolts	40	10	4.05
T201	Seal for 3" Caps and Hose Adapters, Bulk	12	2	1.29

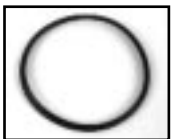

Valterra Valve Replacement Seals

Fits Valterra Old Style Valves

T1001-7	1-1/2" Valterra Replacement Seal, Bulk	50	1	.93
T1001-7VP	Two 1-1/2" Seals, Carded W/nuts, bolts	50	7	3.19
T1002-7	2" Valterra Replacement Seal, Bulk	50	1	1.13
T1002-7VP	Two Valterra 2" Seals, Carded, w/Nuts,bolts	50	6	3.61
T1003-7	3" Valterra Replacement Seal, Bulk	50	2	1.38
T1003-7VP	Two Valterra 3" Seals, Carded, w/Nuts,bolts	100	23	4.05
T201	Seal for 3" Caps and Hose Adapters, Bulk	12	2	1.29



Part No.

Ctn.Qty.

Ctn.Wt.

Retail Price

Valve Replacement Handles

All replacement handles are threaded for easy attachment. Fits Bladex or Valterra Old Style Valves

T1003-6	Plastic Valve Handle, Bulk - Black	25/300	1/6	1.53
T1003-6VP	Plastic Valve Handle, Carded	50	3	2.03
T1003-6M	Metal Valve Handle, Bulk	25	2	3.19
T1003-6MVP	Metal Valve Handle, Carded	50	5	3.73



Cable Actuated Waste Valves

Valterra's patented Cable Valve System converts hard to access valve handles to a simple push/pull placement. Cable handles can be positioned at the bottom of an RV sidewall, or within a control access compartment with bulkhead installation.

- Cable allows waste valves to be in a location protected from damage normally occurring in low and exposed areas.
- Easy-to-access cable handle permits a simple push/pull motion to operate the waste valves, eliminating difficult side pulls.

TC172	72" Flexible Cable Kit w/ 1 1/2" Valve	4	12	54.38
TC372	72" Flexible Cable Kit w/ 3" Valve	4	14	59.88
TC1372	Two 72" Flexible Cable Kits w/ 1 1/2" & 3" Valves	4	27	114.25



Valve Extension Rods, Kits and Parts

Adjustable 10" to 12" extension rod kit comes with handle locking tab, extension rod, and coupler.

T1046-10VP	Adjustable Extension Rod Kit	100	30	10.00
T1003-8	4" Extension Rod Coupler	1	-	5.95
T1003-46	Extension Rod Mounting Bracket w/Locking Thread	1	-	1.26
T304	Hex Coupler	1	-	.85



Termination Adapters

T1015-2	3" WYE - 3" Bayonet X 3" Slip Hub x 2" Slip Hub	1/16	1/13	8.11
T1029-1	3" Bayonet x 3" Spigot	68	18	2.27
T1029-2	3" Bayonet x 3" Slip Hub	72	19	2.27
T1029-4	3" Bayonet x 3" Male Thread	1/70	1	3.61
T1027	Rigid Sewer Pipe Bayonet Adapter 3" Male Thread x Bayonet Hooks	40	15	5.65



Part No. **Ctn.Qty.** **Ctn.Wt.** **Retail Price**

Flanged Fittings for Valve Attachments

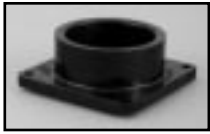

T1005 3" SLIP HUB 60 18 2.42

T1005-1 1-1/2" SLIP HUB - Also used as 2" spigot 50/200 7/24 1.75



T1005-2 2" SLIP HUB 25/150 4/19 1.85



T1006 3" SPIGOT 65 19 2.39

T1006-1 1-1/2" SPIGOT 50/260 5/22 1.52



T1006-2 2" SPIGOT 25/180 4/22 1.85



T1007 3" FEMALE THREAD 1/96 1/26 5.25

T1008 3" MALE THREAD 1/84 13 3.87



T1008-1 1-1/2" MALE THREAD 25/100 4/18 2.11



T1009 3" BAYONET 24/84 6/15 3.87



T1010 3" SAN TEE REDUCING - 3" bayonet x 3" and 1-1/2" rotating flanges 1/22 14 9.78

T1011 3" SAN TEE REDUCING - 3" bayonet x 3" rotating flange x 1-1/2" slip hub 22 14 8.86



T1012 3" SAN TEE REDUCING - 3" bayonet x 3" rotating flange x 2" slip hub 20 13 8.86

T1013 3" DOUBLE SAN TEE REDUCING 3" bayonet x 3" rotating flange x 2" slip hub x 1-1/2" slip hub 18 13 8.86



T1014 3" WYE REDUCING - 3" bayonet x 3" stationary flange x 1-1/2" rotating flange 14 11 9.32

T1014-1 3" WYE REDUCING - 3" bayonet x 3" rotating flange x 1-1/2" rotating flange 14 13 9.32



T1015 3" WYE REDUCING - 3" bayonet x 3" stationary flange x 2" slip hub 16 12 8.37

T1015-1 3" WYE REDUCING - 3" bayonet x 3" rotating flange x 2" slip hub 14 14 13.08

	Part No.		Ctn.Qty.	Ctn.Wt.	Retail Price
	T1030	HEEL INLET 1/4 BEND - 3" bayonet x 3" rotating flange x 2" slip hub	18	14	13.08
	T1030-1	HEEL INLET 1/4 BEND - 3" slip hub x 3" rotating flange x 2" slip hub	1/15	1	13.08
	T1031	HEEL INLET 1/4 BEND - 3" bayonet 3" & 1-1/2" rotating flanges	1/15	1	14.01
	T1035	90° ELL - 3" bayonet x 3" rotating flange	1/20	1	13.50
	T1035-1	90° ELL - 3" slip hub x 3" rotating flange	1/18	1	13.50
	T1035-2	90° ELL - 3" spigot x 3" rotating flange	1/18	1	13.50
	T1036	TWO-WAY ELL - 3" bayonet x 3" rotating flange x 1-1/2" rotating flange	16	13	15.86
	T1036-1	TWO-WAY ELL - 3" spigot x 3" rotating flange x 1-1/2" rotating flange	1/16	1	15.86
	T1037	THREE-WAY ELL 3" bayonet x 3" rotating flange x 2" hub inlet x 1-1/2" rotating flange	1/16	1	16.79
	Bladex Double Valve Assemblies				
	<ul style="list-style-type: none"> • Replumbing is more convenient with factory assembled valves. • Eliminates the need for solvent bonding 1-1/2" & 3" valves together. • Time-saving and labor-saving. 				
	3" and 1-1/2" ROTATING SAN TEE DOUBLE VALVE ASSEMBLY				
	T18	3" HUB x 1-1/2" HUB x 3" BAY w/Cap	8	19	32.83
	3" and 1-1/2" ROTATING WYE DOUBLE VALVE ASSEMBLY				
	TR38	3" HUB x 1-1/2" HUB x 3" BAY w/Cap	6	16	31.85
	3" and 1-1/2" HEEL INLET 1/4 BEND DOUBLE ROTATING VALVE ASSEMBLY				
	T68	3" HUB x 1-1/2" HUB x 3" BAY w/Cap	6	16	32.70
	3" and 1-1/2" DOUBLE ELL DOUBLE ROTATING VALVE ASSEMBLY				
	T80	3" HUB x 1-1/2" HUB x 3" BAY w/Cap	8	20	32.10



CAPS, HOSE ADAPTERS & ACCESSORIES

Part No. **Ctn.Qty.** **Ctn.Wt.** **Retail Price**



Caps & Accessories

- New improved design allows your caps to twist on and off easily.
- Reinforced ears give longer lasting durability.

T1020	3" TERMINATION CAP w/Bayonet Hooks, Black	160	22	2.29
T1020VP	SAME AS ABOVE, CARDED	50	11	2.93
T1020-I	3" TERMINATION CAP w/Bayonet Hooks, Black 3/4" hose thread connection w/Cap	125	22	2.96
T1020-IVP	SAME AS ABOVE, CARDED	36	11	3.61
T1020-IDW	3/4" HOSE CAP w/Strap, White	100	3	.54
T1020-IDWVP	SAME AS ABOVE, CARDED	50	2	1.06
T1020-ID	3/4" HOSE CAP w/Strap, Black	100	3	.54
T1020-IDVP	SAME AS ABOVE, CARDED	50	2	1.06
T1020-IE	3/4" MALE THREAD HOSE PLUG w/Strap, Off White	100	2	.38
T1020-IEVP	SAME AS ABOVE, CARDED	50	-	.88
TSV7	STRAP, Black	50	1	.30
TSV7RS	TAB FOR STRAP ATTACHMENT(Not Shown), Black	100	-	.28



Hose Adapters and Accessories

- New improved design allows your adapters to twist on and off easily.
- Reinforced ears give longer lasting durability.
- Straight hose adapters fit inside standard hose bumpers.

T201	SEAL FOR 3" CAPS & HOSE ADAPTERS	12	-	1.29
T1024	3" STRAIGHT HOSE ADAPTER, Black 3" bayonet hooks x 3" hose	100	16	1.88
T1024VP	SAME AS ABOVE, CARDED	30	8	2.52
T1025	45° HOSE ADAPTER, Black	50	14	2.19
T1025VP	SAME AS ABOVE, CARDED	20	8	2.83
T1050PB	RV SANITARY WRENCH (Polybagged)	15	4	6.44



Clear Hose Adapters

- Clear material allows you to see when it's clean.
- 45° adapters reduce stress on your hose while dumping
- No hose clamps needed with bayonet lug adapter. Just twist on you current hose adapter and you're ready to go.

T1026	45° HOSE ADAPTER, Clear	50	14	3.00
T1026-I	45° HOSE ADAPTER w/ Bayonet Lugs, Clear	36	11	4.88

Universal Adapter

- Converts Thetford system to Valterra/Grentec/Anonda caps & hose adapters.

T05-2285VP	UNIVERSAL ADAPTER Carded - Black	30	8	5.00
------------	----------------------------------	----	---	------



Part No. **Ctn.Qty.** **Ctn.Wt.** **Retail Price**



La Toilette

- Operates at all water pressures to maintain consistent bowl water level.
- Low water consumption for more flushes per holding tank.
- Available in two attractive colors

Q8000	LA TOILETTE,WATER SEAL TOILET, Ivory	1	13.0	82.23
Q8000TW	LA TOILETTE,WATER SEAL TOILET,True White	1	13.0	82.23

Replacement Parts

Available in both ivory or true white colors.



Q08070	COVER, Ivory	1	1.5	18.05
Q08070TW	COVER,True White	1	1.5	18.05



Q08060	SEAT, Ivory	1	1.0	13.85
Q08060TW	SEAT,True White	1	1.0	13.85



Ball Valve

Simple steps for easy installation.

Q23679VP	BALL VALVE, Carded	12	3.0	23.13
----------	--------------------	----	-----	-------

Floor Gasket

- Heavy duty sponge rubber material
- Universal for all types of RV toilets.



Q23653	FLOOR GASKET, Bulk	1	.5	1.88
Q23653VP	FLOOR GASKET, Carded w/Hold Down Bolts	1	.5	3.88

Rocket Hand Pumps

- Special "Prime Lock" handle position
- High flow piston action design
- Replaceable parts
- Available in chrome or colored body



RP800	ROCKET HAND PUMP, Chrome	12	11	30.63
RP801	ROCKET HAND PUMP, Black	12	11	28.13
RP802	ROCKET HAND PUMP, White	12	11	28.13
RP320	REPAIR KIT	20	2	7.50

Part No. **Ctn.Qty.** **Ctn.Wt.** **Retail Price**



Swivel Drain Connectors

T01-0021	1-1/2" x 3/4" 90° DRAIN CONNECTOR	25/250	-	1.62
T01-0091VP	SAME AS ABOVE, CARDED	25	3	2.29
T01-0024	1-1/2" x 3/4" DRAIN CONNECTOR	25/300	2/8	2.50
T01-0094VP	SAME AS ABOVE, CARDED	25	2	3.17
RF839	90° DRAIN ELBOW w/ 3/4" BARB END	100/400	1/17	1.96
RF890	90° DRAIN ELBOW 1-1/2" FEM. SWIVEL x 3/4" BARB	25	-	2.78

Floor Flanges



T05-0782	4" x 3" x 1.88" MALE THREADED	12	5	5.25
T05-0784	4" x 3" x 1.80" FEMALE THREADED	12	6	5.38

Side Vent Cover

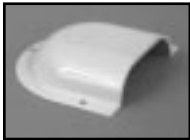

R1007	Vent Cover, Ivory	50	4	1.13
-------	-------------------	----	---	------

3" ABS Threaded Nipples



T3503	3" x 3" Threaded on Both Ends (TBE)	60	13	2.55
T3504	3" x 4" TBE	48	15	3.22
T3506	3" x 6" TBE	32	16	4.51
T3508	3" x 8" TBE	24	16	5.28
T3510	3" x 10" TBE	12	15	7.08
T3512	3" x 12" TBE	12	17	7.70
T3523	3" x 3" Thread on One End (TOE)	60	15	2.91
T3524	3" x 4" TOE	48	16	3.63
T3528	3" x 8" TOE	24	17	6.88

Tank Adapters



T1041-1	ECCENTRIC TANK REDUCER 3" spigot x 1-1/2" hub	96	22	2.43
T1041-2	ECCENTRIC TANK REDUCER 3" spigot x 2" hub	1/100	23	2.81
T1040-2	HOLDING TANK FLANGE - 2" hub	1/200	17	1.65

Solvent Cement



A05-0303	ABS SOLVENT CEMENT (1/4PT)	24	9	2.96
A05-0304	ABS SOLVENT CEMENT (For California)	24	9	3.25

Teflon Tape - .0035mil Thickness, .35 Density



A05-0260	1/2" x 260" TEFLON TAPE	144	5	.38
A05-0265	1/2" x 520" TEFLON TAPE	144	6	.60
A05-0266	3/4" x 260" TEFLON TAPE	144	6	.53
A05-0267	3/4" x 520" TEFLON TAPE	144	6	.68

**One TAB
Does it All!**

potty toddy tabs

**IT'S
EASY!**

“The Original One Tab Solution”

- Easy to store and use.
- Treats waste tanks, gray water tanks and portable toilets.
- One tab treats 50 gallons.
- Neutralizes odor completely.
- Liquifies waste and all types of toilet paper.
- Lubricates valve seals.
- Environmentally safe - non-toxic, no formaldehyde.



Potty Toddy Tabs



Part No.		Ctn.Qty.	Ctn.Wt.	Retail Price
Q5000VP	Potty Toddy Tabs, one card of six tabs	80	4/17	4.93



Q5003VP	Potty Toddy Tabs - trial size, one card of two tabs	100	4	1.60
---------	---	-----	---	------



Q5004	Bottle of 50 tabs	1/25	7	31.54
-------	-------------------	------	---	-------



Q5025	Plexiglass Display holds 12 cards (cards not included)	1	3	n/c
-------	--	---	---	-----

Part No.

Ctn.Qty.

Ctn.Wt.

Retail Price



RV Hydroflush

- Breaks up plugged tanks
- Flushes clean the entire waste system including tank, pipe, valve, and drain hose
- Simply attaches to your valve with a quick twist
- Clear plastic makes it easy to see when waste system is clean
- Includes an internal backflow preventor and anti-siphon valve for attachment to fresh water faucet, to protect the fresh water supply.
- Shut off valve has easy-to-turn knob.



F02-4100	RV Hydroflush	18	13	24.00
A01-0144VP	HI Flow Shut Off Valve	30	3	3.75



No-Fuss Flush®

- Jet stream spray removes and flushes away tank deposits
- Installs permanently to waste or gray water tank
- Eliminates the need to drag hose inside RV
- Accessory kit has chrome plated inlet and fittings. Connect No-Fuss Flush® to outside wall of RV for easy hook up.



A70	No-Fuss Flush® w/ check valve	12	4	19.88
A71	No-Fuss Flush® Accessory Kit	12	6	18.26



Marine Products

Super Plug™ *The Ultimate Boat Drain Plug*

Boaters will never have to awkwardly reach under the splash well or over the transom to put in or remove their boat drain plug. With Super Plug™ the gate valve is opened or closed with the ease of lifting or pushing a lever. Super Plug™ can be installed from inside or outside of the transom wall in minutes.

Specifications:

- 1" and 1/2" diameter ports available
- Made of unbreakable plastic
- 18" cable switch assembly (Custom Length are available)
- Stainless steel cable and hardware

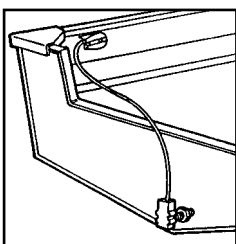

TCP48	1/2" x 48" Cable (Nut not included)	6	6	22.40
TCP48-1	1" x 48" Cable	12	7	23.78

Part No. **Ctn.Qty.** **Ctn.Wt.** **Retail Price**



Flexible Tank Wand

This flexible hose wand easily makes 90° turns under the toilet, enabling you to 'snake' it through to the tank. Allows you to clean your tank more efficiently. Tapered power nozzle eliminates "hang ups" at pipe joints.

A01-0187VP	Flexible Tank Wand, Gray	50	36	10.25
------------	--------------------------	----	----	-------



Master Blaster Tank Wand

The only plastic tank wand that has a POWER NOZZLE, creating one of the most powerful tank cleaning products on the market.

A01-0184VP	Master Blaster Tank Wand	30	12	7.13
------------	--------------------------	----	----	------



Rinse-A-Tank Wand

Rinse-A-Tank wand includes a convenient shut off valve and effective spray nozzle. Attach to hose, place through toilet and simply rinse out tank.

A01-0183VP	Rinse-A-Tank Wand	48	17	6.25
------------	-------------------	----	----	------



Tank Wand Hose Kit

Stop dragging your garden hose through your rig. Now simply connect your tank wand to your bathroom faucet with Valterra's Tank Wand Hose Kit. Enables the use of hot water for better cleaning action. Includes: 1/2" x 5' hose and bathroom faucet-to-hose adapter.

A01-0189VP	Tank Wand Hose Kit	12	7	6.75
------------	--------------------	----	---	------



Gray Flushing Hose

Designed for non-drinking water usage including flushing devices that clean waste tanks or use as a gray water drainage hose. The gray color easily distinguishes it from white drinking water hose.

W01-4180	1/2" x 15' Flushing Hose, Gray	6	14	9.00
W01-4300	1/2" x 25' Flushing Hose, Gray	6	18	10.25



Anti-Siphon Valves

Anti-Siphon Valves are for attachment to the fresh water faucet to prevent the backflow of contaminated water into the fresh water supply.

A01-0141	Anti-Siphon Valve Removable - Plastic, Bulk	30	3	2.25
A01-0141VP	Anti-Siphon Valve, Removable - Plastic, Carded	30	4	2.50
A01-0143	Anti-Siphon Valve, Non-removable - Brass	6/72	1/21	7.23



VALTERRA SEWER DRAIN HOSES

Part No. **Ctn.Qty.** **Ctn.Wt.** **Retail Price**



Quick Drain

Quick Drain RV Drain hose is made of the highest quality wire and vinyl to protect from toilet chemicals and extreme temperatures. Remains flexible and easy to use in all weather conditions.

D04-0047	3" x 10' Bagged, Blue	25	36	4.23
D04-0048	3" x 20' Bagged, Blue	10	25	8.08
D04-0045	3" x 10' Boxed, Blue	12	22	4.79
D04-0046	3" x 20' Boxed, Blue	12	34	8.78



15' Quick Drain Heavy Duty with SIZING RINGS

15' Quick Drain Heavy Duty hose that includes sizing rings for simple attachment of fittings.

D04-0057	15' Heavy Duty, Boxed - Blue	12	40	10.00
----------	------------------------------	----	----	-------



EZ Flush Standard with SIZING RINGS

EZ Flush Standard has 30% more coils than other standard or regular drain hose which produces a smoother interior; reducing waste hangups.

D04-0015	3" x 10' Standard Boxed, Bronze	12	23	6.38
D04-0016	3" x 20' Standard Boxed, Bronze	6	23	11.85
D04-0024	3" x 10' Standard Bagged, Bronze	20	34	6.00
D04-0025	3" x 20' Standard Bagged, Bronze	10	30	11.08



EZ Flush Super Heavy Duty with SIZING RINGS

Maximum leak protection! No other hose has a thicker vinyl covering over the wire.

D04-0012	3" x 10' Heavy Duty, Boxed, Bronze	12	31	8.34
D04-0012PB	3" x 10' Heavy Duty, Bagged - Bronze	10	25	7.83
D04-0040	3" x 20' Heavy Duty, Boxed, Bronze	6	29	15.50
D04-0041	3" x 10' Heavy Duty, Boxed, Blue	12	31	8.34
D04-0042	3" x 20' Heavy Duty, Boxed, Blue	6	27	15.50
D04-0040PB	3" x 20' Heavy Duty, Bagged, Bronze	6	26	14.78



EZ Flush Triple Wrap with SIZING RINGS

This is the ultimate drain hose. Three wraps of vinyl allow the outside layers to take the abuse of abrasion and weathering, while the inside layers continue to provide leakproof performance. Additionally, this hose comes with .054" wire making this hose strong enough to stand on.

D04-0050	3" x 10' Triple Wrap, Boxed - Gray	6	26	15.63
D04-0054	3" x 20' Triple Wrap Individually Boxed, Gray	3	24	29.69
D9500	Drain Hose Display	1	6	n/c



Drain Hose with Adapters

D04-0094	10' Heavy Duty Hose, Bronze, Bagged Assembled with One 45° Hose Adapter	10	25	11.90
D04-0095	20' Heavy Duty Hose, Bronze, Bagged Assembled with One 45° Hose Adapter	10	43	19.06





SEMI-RIGID SEWER HOSE

Part No.		Ctn.Qty.	Ctn.Wt.	Retail Price
	Semi-Rigid Sewer Hose			
	D04-0017	3" x 10' Semi-Rigid Sewer Hose, Polyethylene	10	22







DRAIN HOSE ACCESSORY

Part No.		Ctn.Qty.	Ctn.Wt.	Retail Price
	Sewer Hose Spreader			
	A73	Sewer Hose Spreader, Green	24	13

Place spreader in sewer hose and pull handles apart. Expands hose for simple adapter installation.



E-Z HOSE CARRIERS

Part No.		Ctn.Qty.	Ctn.Wt.	Retail Price	
	E-Z Hose Carrier & Accessories				
	A04-0150	26" EZ HOSE CARRIER	6	16	23.95
	A04-0151	46" EZ HOSE CARRIER	4	17	31.11
	A04-0153	64" EZ HOSE CARRIER	1	5	38.24
	A04-0155	94" EZ HOSE CARRIER	1	8	48.64
	A04-0156	EZ hose carrier center support saddle, White	1/100	14	3.78
	A04-0157	EZ hose carrier saddle, White	1/80	14	4.15
	A04-0159	EZ hose carrier old style cap & strap, White	1/80	14	4.15
	A04-0161	EZ hose carrier cap & strap, White	1/150	18	5.00

ABS plastic hose carrier comes assembled with mounting brackets for easy installation. Interlocking cap has a round handle for easy quarter turn on-off and a strap to prevent loss. Mounting hardware included.

Part No.

Ctn.Qty.

Ctn.Wt.

Retail Price



EZ Couplers

EZ Coupler makes sewer hose connections simple with the patented threaded system that eliminates hose clamps. Just twist on the fittings for a leak proof connection. The "Red Fittings" are made of long-lasting polypropylene material.

EZ Coupler System

Includes: valve/hose adapter, coupler and 90° elbow.

F02-3303	EZ COUPLER SYSTEM, Red - Carded	4	8	30.98
----------	---------------------------------	---	---	-------



Valve/Hose Adapter

- Adapts drain hose to valve system with four bayonet attachments for a leakproof seal.
- Twists right onto your RV sewer hose
- No hose clamps needed.

F02-3101	EZ COUPLER HOSE ADAPTER, Red -Bulk	40	15	9.07
F02-3101VP	EZ COUPLER VALVE ADAPTER, Red - Carded	14	7	9.80



Coupler

- The original EZ Coupler couples two hoses together with a quick twist
- No hose clamps needed.
- Self-threading fitting extends two drain hoses for those difficult to reach sewers.

F02-3102	EZ COUPLER, Red - Bulk	42	17	8.47
F02-3102VP	EZ COUPLER, Red - Carded	14	7	9.23



90° Elbow

- Multi tiered sewer fitting simply press fits into sewer outlets for a fast and easy set up.
- Self-threading, twist right onto your RV sewer hose. No hose clamps needed.
- Two piece design allows hose to remain attached for easy storage.
- 3/4 " threaded connector for 2nd gray water tank.
- Drip Cap included.

F02-3103	EZ COUPLER UNIVERSAL SEWER ADAPTER, Red - Bulk	14	10	12.08
----------	--	----	----	-------



Sewer Thread Attachment

- Press fits onto your EZ Coupler Universal Adapter.
- For those parks that require threaded connections.

F02-3105	SEWER THREAD ATTACHMENT, Red -Bulk	54	14	7.52
----------	------------------------------------	----	----	------

Part No. **Ctn.Qty.** **Ctn.Wt.** **Retail Price**



EZ Coupler (Continued)

F02-3305VP	EZ COUPLER 90° SEWER ADAPTER & THREAD ATTACHMENT, Carded, Red (Includes F02-3103 & F02-3105)	8	8	20.53
------------	--	---	---	-------



Drip Cap

Press fits onto the hose section of the EZ Coupler 90° F02-3103, to eliminate dripping while stored.

F02-3107	EZ coupler drip connector cap w/Strap, Red - Bulk	30	3	2.88
----------	---	----	---	------



Bayonet Fitting

Create an extension hose with two EZ Coupler parts(F02-3101 & F02-3108) that connect with a quick snap.

F02-3108	EZ Coupler Bayonet Fitting, Red - Bulk	40	14	8.48
----------	--	----	----	------



Waste Valve Cap

Cap w/Handle and 3/4" hose connection. For ease of use, this handle is great.

F02-3106BK	EZ COUPLER VALVE CAP, w/HANDLE, Black - Bulk	52	13	8.57
F02-3106VP	EZ COUPLER CAP w/HANDLE, Black - Carded	16	7	8.33



Adapter Seal

Replacement seal for use on part# F02-3101 & F02-3106BK

F02-3104VP	EZ COUPLER SEAL, Carded	1	-	2.03
------------	-------------------------	---	---	------



Replacement Connector

Bottom half replacement for 90° universal adapter F02-3103

F02-3109	EZ Coupler Replacement Sewer Connector, Red - Bulk	24	7	6.25
----------	--	----	---	------



Clear 45° Adapter

Clear material allows you to see when it's clean. Twist right on without the need of hose clamps.

F02-3111	EZ Coupler 45° Hose Adapter w/Threads, Clear - Bulk	22	8	9.88
----------	---	----	---	------



THE "QUICK CONNECT" SEWER HOSE SYSTEM

Part No. **Ctn.Qty.** **Ctn.Wt.** **Retail Price**



"Quick Connect" RV Extension Hose

15' Quick Drain Heavy Duty hose includes pre-attached Quick Connect bayonet adapters. The quick and simple way to extend hoses without the need for additional fittings.

D04-0036	15' Quick Connect Extension Drain Hose, Boxed, Blue	5	24	17.38
----------	---	---	----	-------



"Quick Connect" Extension Drain Hose Fittings

Quick Connect Extension Hose Fittings create an extension hose that's interchangeable with your current primary hose. A quick twist makes a leak-proof positive seal. Includes: 3" straight hose adapter, Bayonet fitting, and two #48 Hose clamps.

F02-2029VP	Quick Connect System	24	14	8.32
------------	----------------------	----	----	------



"Quick Connect" Bayonet Fitting

Used in conjunction with hose adapter to extend primary hose.

F02-2028	Bayonet Hose Fitting, Black	100	18	4.33
F02-2028VP	Bayonet Hose Fitting, Carded - Black	30	8	5.03

SEWER ADAPTER & ACCESSORIES



Speedi Sewer Adapter

Two piece funnel type adapter is easy to use and inexpensive. Simply fits into your sewer outlet for easy tank drainage.

F04-0100	Speedi Sewer Adapter	24	11	6.64
----------	----------------------	----	----	------



Sewer Sponge Ring

For RV parks requiring a gas-tight sewer connection.

F02-4500	4" x 3" Sewer Sponge Ring, Hard	50	28	3.61
F02-4600	4" x 3" Sewer Sponge Ring, Soft	50	28	3.00

	Part No.		Ctn.Qty.	Ctn.Wt.	Retail Price
         		Drain Hose Couplers			
	F02-2023	90° HOSE COUPLER 3" hose x 3" hose	45	13	2.96
	F02-2024	45° HOSE COUPLER	50	11	2.96
	F02-2025	STRAIGHT HOSE COUPLER 3" hose x 3" hose - Yellow	55	6	1.16
	F02-2025VP	SAME AS ABOVE, CARDED	30	5	1.80
	F02-2025BK	STRAIGHT HOSE COUPLER 3" hose x 3" hose - Black	55	6	1.03
	F02-2027	WYE - 3" hose x 3" hose x 3" hose	25	9	5.41
		Sewer Inlet Fittings			
	F02-2000	FEMALE 90° CLOSE ELBOW 3" hose x 3" fipt	40	13	3.22
	F02-2001	FEMALE 60° CLOSE ELBOW 3" hose x 3" fipt	40	13	3.30
F02-2002	MALE 90° CLOSE ELBOW 3" hose x 3" mipt	40	13	3.48	
F02-2003	MALE 60° CLOSE ELBOW 3" hose x 3" mipt	45	12	3.45	
F02-2004	FEMALE ADAPTER 3" hose x 3" fipt	65	15	2.52	
F02-2005	MALE ADAPTER 3" hose x 3" mipt	65	13	2.27	
F02-2015	3" MALE THREAD PLUG - W/10" chain	1/150	4	4.25	
F02-2018	3" FEMALE THREAD CAP - W/10" chain	1/125	27	4.25	
F02-2019	3" FEMALE THREAD DRAIN ADAPTER	1/95	19	2.58	

Part No. **Ctn.Qty.** **Ctn.Wt.** **Retail Price**



High Pressure Drinking Water Hose

High pressure, fresh water drinking hose • Non-Toxic • Made of FDA Material. Easy to Use hose gripper included. 1/2" hoses | 60 psi working pressure. 5/8" hoses | 20 psi working pressure.

W01-5048	1/2" x 4' Drinking Water Hose, White	10	5	5.88
W01-5120	1/2" x 10' Drinking Water Hose, White	10	11	8.63
W01-5180	1/2" x 15' Drinking Water Hose, White	10	11	9.63
W01-5300	1/2" x 25' Drinking Water Hose, White	6	12	11.63
W01-5600	1/2" x 50' Drinking Water Hose, White	5	25	17.50
W01-2005	1/2" x 250' Drinking Water Hose, White (Bulk)	1	23	89.50
W01-2105	1/2" x 250' High Pressure Water Hose, White (Bulk)	1	28	99.75
W01-6300	5/8" x 25' Drinking Water Hose, White	6	12	14.38
W01-6600	5/8" x 50' Drinking Water Hose, White	8	40	22.50



Clear Vinyl Tubing

Flexible, non-toxic, resistant to corrosion

W01-1200PB	1/4" I.D. x 10' Clear Vinyl Tubing w/ Header	10	5	3.25
W01-1200	1/4" I.D. x 100' Boxed	1	4	20.00
W01-1400PB	3/8" I.D. x 10' Clear Vinyl Tubing w/ Header	10	6	3.90
W01-1400	3/8" I.D. x 100' Boxed	1	5	25.63
W01-1600PB	1/2" I.D. x 10' Clear Vinyl Tubing w/ Header	5	4	4.55
W01-1600	1/2" I.D. x 100' Boxed	1	5	31.88
W01-1700	3/8" I.D. x 100' Reinforced Clear Vinyl Tubing	3	41	46.00
W01-1800	1/2" I.D. x 50' Reinforced Clear Vinyl Tubing	6	44	35.75
W01-1900	5/8" I.D. x 50' Reinforced Clear Vinyl Tubing	4	40	44.38



High Pressure Water Lines

Tasteless, odorless, safe for permanent and semi-permanent cold water applications.

Bronzeline

W01-0001	1/2" x 5' Bronzeline Water Hose	15	7	4.48
W01-0002	1/2" x 10' Bronzeline Water Hose	10	8	7.05
W01-0003	1/2" x 15' Bronzeline Water Hose	6	8	9.38
W01-0004	1/2" x 25' Bronzeline Water Hose	5	9	13.05

Ebonyline

W01-0009	1/2" x 5' Ebonyline Water Hose, Black	15	7	4.20
W01-0010	1/2" x 10' Ebonyline Water Hose, Black	10	7	6.18
W01-0011	1/2" x 15' Ebonyline Water Hose, Black	10	11	7.75
W01-0012	1/2" x 25' Ebonyline Water Hose, Black	5	8	7.98



	Part No.		Ctn.Qty.	Ctn.Wt.	Retail Price
	BARBED MALE ADAPTER				
	RF850	1/4" MPT x 3/8" BARB	25	.5	.33
	RF847	1/4" MPT x 1/2" BARB	25	.5	.38
	RF834	3/8" MPT x 3/8" BARB	25	.5	.38
	RF840	3/8" MPT x 1/2" BARB	25	.5	.43
	RF878	3/8" MPT x 5/8" BARB	25	.5	.45
	RF883	1/2" MPT x 3/8" BARB	25	.5	.35
	RF841	1/2" MPT x 1/2" BARB	25	.5	.45
	RF880	1/2" MPT x 5/8" BARB	25	.5	.38
	BARBED COUPLER				
	RF855	3/8" BARB x 3/8" BARB	25	.5	.33
	RF845	1/2" BARB x 1/2" BARB	25	.5	.38
	BARBED REDUCER COUPLER				
	RF884	3/8" BARB x 1/4" BARB	25	.5	.33
	RF885	1/2" BARB x 3/8" BARB	25	.5	.33
	BARBED 90° ELL MALE ADAPTER				
	RF851	1/4" MPT x 3/8" BARB	25	.5	.73
	RF848	1/4" MPT x 1/2" BARB	25	.5	.73
	RF835	3/8" MPT x 3/8" BARB	25	.5	.73
	RF842	3/8" MPT x 1/2" BARB	25	.5	.70
	RF877	3/8" MPT x 5/8" BARB	25	.5	.78
	RF882	1/2" MPT x 3/8" BARB	25	.5	.73
	RF846	1/2" MPT x 1/2" BARB	25	.5	.70
	RF881	1/2" MPT x 5/8" BARB	25	.5	.78
	BARBED 90° ELL				
	RF854	3/8" BARB x 3/8" BARB	25	.5	.63
	RF844	1/2" BARB x 1/2" BARB	25	.5	.63
	BARBED TEE MALE ADAPTER				
	RF853	1/4" MPT x 3/8" BARB x 3/8" BARB	25	.5	.75
	RF833	3/8" MPT x 3/8" BARB x 3/8" BARB	25	.5	.75
	RF832	3/8" MPT x 1/2" BARB x 1/2" BARB	25	.5	.55
	RF849	1/2" MPT x 1/2" BARB x 1/2" BARB	25	.5	.85
	BARBED TEE				
	RF852	3/8" BARB x 3/8" BARB x 3/8" BARB	25	.5	.65
	RF843	1/2" BARB x 1/2" BARB x 1/2" BARB	25	.5	.65

Part No. **8" x 16" x** **U.S. Gal.** **Liters** **Wt.** **Retail Price**

Fresh Water Tanks



- The only solvent weldable water tank - add fittings anywhere
- Light-weight, completely algae-free black ABS plastic
- Tasteless, odorless, and non-toxic
- Will never rust or corrode. Made of high-grade plastic polymers
- One-piece extruded construction eliminates the possibility of leakage
- Baffled every 18 inches for surge control
- Easily installed, universal design
- Supplied with 3/8" threaded, fitting inserts; three on each end
- For non-pressure applications



R8009	9"	4.5	17.0	3	36.10
R8012	12"	6.0	23.0	4	39.00
R8018	18"	9.0	34.0	5	45.65
R8024	24"	12.0	45.0	6	53.08
R8030	30"	15.0	57.0	7	64.85
R8036	36"	18	68.0	8	73.83
R8042	42"	21.0	80.0	9	84.55
R8048	48"	24.0	91.6	11	95.25
R8054	54"	27.0	102.0	12	104.75
R8060	60"	30.0	114.0	13	110.05
R8066	66"	33.0	125.0	14	115.53
R8072	72"	36.0	136.0	15	121.40



Part No. **Ctn.Qty.** **Ctn.Wt.** **Retail Price**

ABS TANK FILL KITS

Each Kit Includes:

- 1-1/4" fill fitting
- Two 3/8" drain/vent adapters
- 1/4 pint solvent cement
- Two 3/8" 90° barbed ell adapters
- 3/8" plug

RK907	90° barbed elbow fill kit	1	-	7.34
RK907A	90° barbed elbow fill kit, no cement	1	-	4.75
RK908	Straight barbed fill kit	1	-	7.11
RK908A	Straight barbed fill kit, no cement	1	-	4.50
RK909	Threaded fill kit w/cap for manual filling	1	-	8.55
RK909A	Threaded fill kit w/cap for manual filling, no cement	1	-	5.95

FILL FITTINGS & ADAPTERS

RF835	90° elbow 3/8" MIPT x 3/8" barb	1	-	.73
RF836	Fill cap 1-1/2" FPT	1	-	1.98
RF865	Pipe plug 3/8" MPT	1	-	.95
RF907	Barbed fill elbow 1-1/4"	1	-	1.50
RF908	Barbed fill straight 1-1/4"	1	-	1.18
RF909	Fill thread adapter 1-1/2" MPT	1	-	1.45
RF922	Drain nut 3/8" FPT	1	-	1.35

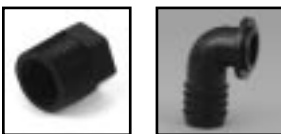

Part No. **Ctn.Qty.** **Ctn.Wt.** **Retail Price**



Quick Fill Pigtails

Our Quick Fill Pigtail slips easily into all water tank fill openings and cuts fill time substantially by reducing air back flow. Pigtails with shut off valves allow adjustment of water flow for maximum fill rate.

A01-0030	QUICK FILL PIGTAIL without SHUT OFF	20	3	1.85
A01-0030VP	SAME AS ABOVE, CARDED	80	11	2.55
A01-0031	QUICK FILL PIGTAIL with SHUT OFF	20	2	2.38
A01-0031VP	SAME AS ABOVE, CARDED	80	10	3.24



Fill Spout and Water Inlets

RF911	Water Fill, Ivory (1-3/8" x 1-1/4" Barb Inlet)	50	6	4.38
R920	Flush Mount Telescoping Water Fill (1-3/8" x 1-1/4" Barb Inlet), Ivory - Bulk	50	14	4.93
R920VP	Same as Above, Carded	10	4	5.63
R920PW	Flush Mount Telescoping Water Fill (1-3/8" x 1-1/4" Barb Inlet), Parchment White - Bulk	50	14	4.93
R920PWVP	Flush Mount Telescoping Water Fill, Parchment White - Carded	10	4	5.63
R920TW	Flush Mount Telescoping Water Fill, True White - Bulk	50	14	4.93
R920TWVP	Flush Mount Telescoping Water Fill, True White - Carded	10	4	5.63

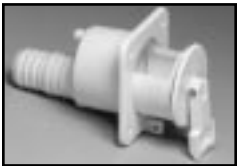

"Hose Fixer" Water Hose Repair Fittings

Repairs 1/2" and 5/8" water hoses.

A01-0050VP	Hose x male hose thread, Carded	50	4	1.55
A01-0055VP	Hose x female, hose thread, Carded	50	4	1.55
A01-0060VP	Hose x hose, Carded	50	5	1.68



Hose Shut Offs

A01-0125VP	Single hose shut off - Plastic, Carded	50/200	4/13	1.50
A01-0130VP	Double hose shut off - Plastic, Carded	50	6	2.38
A01-0131VP	Double hose shut off - Metal, Carded	20	6	4.60
A01-0132VP	Deluxe double hose shut off - Plastic, Carded	50	8	3.13
A01-0135VP	Power nozzle shut off - Plastic, Carded	50	4	2.28
A01-0136VP	Pistol nozzle - Plastic, Carded	36	5	1.85
A01-0134VP	Pistol nozzle - Metal, Carded	36	8	3.33
A01-0140VP	4 way spray nozzle	12/48	3/13	3.50
A01-0144VP	Hi flow shut off valve The 3/8" internal ball provides maximum flow.	30	3	3.75





FRESH WATER ACCESSORIES

Part No.		Ctn.Qty.	Ctn.Wt.	Retail Price
----------	--	----------	---------	--------------

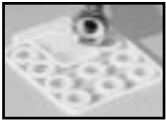

Hose Washers

W1516	Garden Hose Washer, Bag of 250 - Yellow	1	1	8.39
W1516VP	Garden Hose Washer 10 per Card, Yellow	100	5	.49



W1526	Garden Hose Washer W/Screen, Bag of 100 - Yellow	1	1	32.45
W1526VP	Garden hose Washer W/Screen, 3 per Card - Yellow	100	4	1.42



Gripper

Press fits over female hose fittings creating greatly improved gripping power. Eases twist-on connections and stops leaks.

A01-0022	Hose Grippers, Bulk	100	2	.54
A01-0022VP	Hose Grippers - 2 per Card	50/200	4/16	1.62

Quick Connects

A01-0128VP	Hose Quick connect - Plastic	30/120	4/18	3.20
A01-0137VP	Quick connect with 90° Hose Saver Adapter - Plastic	40	8	4.00



RVing BOOKLETS

Part No.		Ctn.Qty.	Ctn.Wt.	Retail Price
----------	--	----------	---------	--------------

RV Booklets

- Hundreds of helpful hints to make RVing easy, safe, and fun.
- Organized by major systems, booklet clearly explains "how to use" your RV properly, the first time.
- Topics covered concisely and in easy to understand language; and excellent troubleshooting manual.
- Includes essential load list, check list, and data sheets.
- No boring "war stories".



Trailers & Fifth Wheels Made Easy

A02-2000	Trailers & Fifth Wheels Made Easy	10	3	6.00
----------	-----------------------------------	----	---	------

Motorhomes Made Easy

A02-3000	Motorhomes Made Easy	10	3	6.00
----------	----------------------	----	---	------

Part No.		Ctn.Qty.	Ctn.Wt.	Retail Price
----------	--	----------	---------	--------------

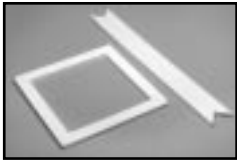

Air Conditioning Seal

A10-1414	14" Square air conditioning seal in cardboard sleeve, White	10	6	11.59
----------	---	----	---	-------



E-Z Wire Hatch

A10-0800	Entry hatch for trailer cord - Ivory	80	11	4.12
----------	--------------------------------------	----	----	------



Trailer Tongue Jack Stand

- Supports the trailer tongue without the worry of sinking into the asphalt on hot days.
- Eliminates the need to tote and store bulky wood blocks.
- Weighs only 2 lbs.
- Holds up to 10,000 lbs.
- Perfect for RV or boat trailer: 8-5/8" diameter x 8-3/8" high.

A10-0900	Trailer tongue jack stand	12	22	15.45
----------	---------------------------	----	----	-------



Non-Skid Grip Tape

- Improves footing on steps, ladders, and trailer frames.
- Can be cut to shape.
- Adheres to any clean, dry non-porous surface.
- Durable in wet or dry conditions.

A10-2160	1" x 60' Non-Skid, Black	40	34	13.78
A10-2260	2" x 60' Non-Skid, Black	1	2	30.49
A10-2460	4" x 60' Non-Skid, Black	1	3	55.16
A10-2660	6" x 60' Non-Skid, Black	1	5	82.88
A10-2624	6" x 24" Non-Skid, Black - Carded	24	10	6.41
A10-2210VP	2" x 10' Non-Skid, Black - Carded	48	18	5.97
A10-2112	1" x 12" Glow in the Dark Non-Skid, 3 per Pack.	80	10	1.60



Gas Mantles

New clip on style.

A10-0003	BERET SOFT MANTLES (2 per pk)	1	-	2.81
----------	-------------------------------	---	---	------

Part No. **Ctn.Qty.** **Ctn.Wt.** **Retail Price**



Awning Strap

Secures awnings in wind and rain. Awning tie-down strap comes complete with wide, 2" webbing, zinc-plated 13" stakes and tension spring, brass-plated grommets and extra heavy zinc-plated buckles.

A30-0100	AWNING STRAP - Black, for 25' awning with straight 13" stakes	12	45	20.75
----------	---	----	----	-------

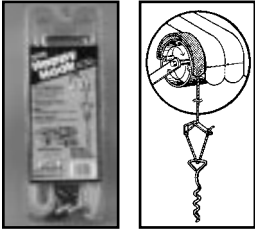

"Happy Hook" Awning Tie Down

Hooks into roller tube of your awning, Keeping tie-down pressure on main support, not on fabric. Fully rotates awning tube to keep fabric tight, which eliminates separation of awning fabric from RV side wall caused by strap tie-downs. Spiral stakes for improved pull-out protection

A30-0200	Two Happy Hooks w/cord and spiral stakes	6/24	15/52	11.50
----------	--	------	-------	-------

Awning Stakes



A30-0215	Spiral Stake, Bulk	12	9	3.13
A30-0217	Angle Stake, Bulk	1/30	24	2.38

Hose Clamps

Stainless Steel Hose Clamps



Part No.	Mfg.No.	Dia./Desc.	Ctn.Qty.	Ctn.Wt.(lbs)	Retail Price
H03-0001	5708	7/16" x 1"	200	9	.78
H03-0002	5710	1/2" x 1-1/8"	500	23	.80
H03-0004	5720	3/4" x 1-3/4"	500	26	.73
H03-0007	5736	7/8" x 2-3/4"	500	32	.75
H03-0012	5740	1-7/8" x 3"	200	14	.65
H03-0008	5748	1-5/8" x 3-1/2"	200	15	1.15
H03-0014	5752	1-7/8" x 3-3/4"	100	9	1.23
H03-0009	5756	2-1/8" x 4"	100	9	1.23
H03-0019	5772	3-1/8" x 5"	100	10	1.20

Clamps are packed in individual boxes of 10.

Stainless Steel Micro-Gear Clamps



H03-0015	6202	1/4" x 5/8"	1000	15	.55
H03-0016	6203	5/16" x 7/8"	1000	16	.55

Clamps are packed in individual boxes of 10.

Valterra Galvanized Drain Hose Clamps



- Galvanized band and housing.
- 5/16" slotted hex head plated steel screw.
- For 3" drain hose.

H03-0058	HG48	1-5/8" x 3-1/2" Bulk	50/500	4/41	.70
H03-0058VP	HG48	Two Clamps, Carded	60	12	1.78

Part No. **Ctn.Qty.** **Ctn.Wt.** **Retail Price**

Inside Air Circulating Fan

Fridgemate Fan



Refrigerator Problems? Fridgemate is a compact, portable air circulation system that puts an end to hot spots that make meat spoil and cold spots that make vegetables freeze. Requires two "D" size alkaline batteries, batteries not included. Batteries run continuously for 30 days.

A10-2604	Fridgemate 3 Volt	60	15	19.65
A10-2612VP	Fridgemate 12 Volt	6	3	30.88

Refrigerator Compartment Vent Fans

Fridgemate Coil Fan



Designed to keep your refrigerator working efficiently in hot weather by cooling the refrigerator coils in the compartment behind the refrigerator. Used specifically for side vented refrigerator compartments common in Airstreams. Thermo-switch turns on when temperature reaches 110° and turns off when temperature is lowered to 90° . Comes with 12' of wire and lighted ON/OFF switch.

A10-2710VP	Coil Fan W/ thermo-switch	6	3	30.88
------------	---------------------------	---	---	-------

Fridgemate Exhaust Fan



Installed at the top of refrigerator compartment to exhaust out hot air which keeps refrigerators operating efficiently in hot weather. Comes standard with thermo-Switch that turns fan on when temperature reaches 110° and turns fan off when temperature is lowered to 90° . Comes standard with 12' of wire and lighted ON/OFF switch.

A10-2812VP	Exhaust Fan with thermo-switch	6	3	30.88
------------	--------------------------------	---	---	-------

Fridgemate Solar Exhaust Fan



Efficient, long-lasting single crystal solar panel will power the Fridgemate exhaust fan for years. Reduces inside refrigerator temperature by keeping refrigerator condenser fins cool and refrigerator operating at peak efficiency. Comes standard with 14ft. of wire, mounting screws, and wire nuts.







A10-2900VP	Solar Exhaust Fan	1/20	14	60.00
------------	-------------------	------	----	-------

Universal Mount Fridge Vent Exhaust Fan

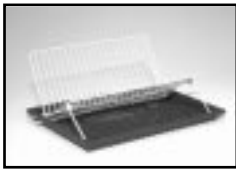

- "Wind Tunnel" design increases refrigerator cooling efficiency up to 40%
- Fully automatic - only activates when fridge is on.
- Turns itself on at 110°, off at 90°
- Can be mounted at the top of fridge rear compartment, or on the back of the refrigerator to blow air over the coils.

A10-2618VP	Universal Mount Fridge Fan	12	10	37.56
------------	----------------------------	----	----	-------

Part No.		Ctn.Qty.	Ctn.Wt.	Retail Price
	Compact Folding Dish Drainer			
	<ul style="list-style-type: none"> Built-in silverware holder Ample ribbed tray for drying glasses, dishes, bowls 			
	<ul style="list-style-type: none"> Size: Opens to 17" x 12" Perfect for small RV kitchens 			
E12-8000	Compact Folding Dish Drainer, White	12	28	13.63
	Folding Dish Drainer			
	<ul style="list-style-type: none"> Chocolate Tray/Almond Rack Folds to 1-1/4" for storage Designed with cup hangers 			
	<ul style="list-style-type: none"> Coated to protect dishes Size: 16-3/4L x 11-1/4W x 1-1/4H 			
E12-7000	Folding Dish Drainer, Chocolate Tray	12	23	14.04
	Standard Dish Drainer			
	<ul style="list-style-type: none"> Space-saving version for easy storage Fits most RV sinks 			
	<ul style="list-style-type: none"> Cushion coated-protects dishes & sinks Size: 13L x 10-1/2W x 5H 			
E12-2009	Standard Dish Drainer, Almond	10	11	7.74
	Shorty Dish Drainer			
	<ul style="list-style-type: none"> Cushion coated-protects dishes & sinks Fits most RV sinks 			
	<ul style="list-style-type: none"> All steel-sanitary-rustproof Size: 13L x 10W x 4H 			
E12-6159	Shorty Dish Drainer, Almond	10	11	7.56
	Over Sink Dish Drainer			
	<ul style="list-style-type: none"> Cushion coated-protects dishes & sinks Fits most RV sinks 			
	<ul style="list-style-type: none"> All steel-sanitary-rustproof Size: 13L x 8-1/2W x 4H 			
E12-5609	Over Sink Dish Drainer, Almond	10	10	7.30
	Silverware Holder			
	<ul style="list-style-type: none"> Hangs inside or outside dish drainer Drain holes in bottom 			
	<ul style="list-style-type: none"> Size: 3-1/2L x 3W x 4H 			
E12-6009	Silverware Holder, Almond	10	2	1.75
	Drain Mat			
	<ul style="list-style-type: none"> Built-in side rims & tapered bottom for draining Hanger loop for easy storage 			
	<ul style="list-style-type: none"> Protects sink top Size: 15L x 11W x 1/2H 			
E12-2059	Drain Mat, Almond	15	10	7.10
	Dish Pan			
	<ul style="list-style-type: none"> Tough, durable plastic Fits most sinks 			
	<ul style="list-style-type: none"> Size: 13L x 10W x 5H 			
E12-2159	Dish Pan, Almond	15	6	3.30

Part No. **Ctn.Qty.** **Ctn.Wt.** **Retail Price**

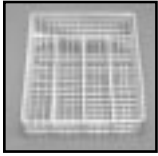

Cutlery Holder

• Vinyl coated wire mesh - sanitary - non-rusting, 12" x 8".

E12-1903	5 Partition Cutlery Holder, White	12	9	6.50
----------	-----------------------------------	----	---	------

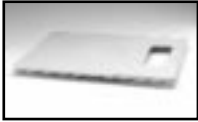

Sink Cover & Cutting Board

• Scrap hole for cuttings • Add extra work space • Size: 15L x 11W x 1H

E12-2109	Sink cover, cutting board - almond	10	14	7.88
----------	------------------------------------	----	----	------

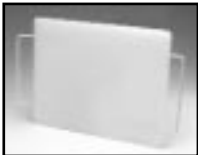

Adjustable Cutting Board

• Polyethylene plastic • Handle easily adjusts to width of different sinks • Size 13L x 10W x 9/16H

E12-2100	Adjustable Cutting Board	6	50	11.95
----------	--------------------------	---	----	-------



Trash Bag Holder

E12-3203VP	Trash Bag Holder For grocery bags with handles, Carded	24/72	8/25	3.35
------------	---	-------	------	------



Medium Magazine Rack

E12-2605	Antique Copper, Size: 14-1/2L x 3W x 9H	6	8	9.84
----------	---	---	---	------

Small Map Rack

E12-2655	Antique Copper, Size: 9 1/2L x 3W x 9H	6	7	8.22
----------	--	---	---	------



Newspaper Rack

E12-2505	Antique Copper, Size: 19L x 3W x 9-1/2H	5	8	12.06
----------	---	---	---	-------

Single Spice Rack

• Spring tension holds contents firmly

E12-2205	Antique Copper, Size: 12-1/2L x 2W x 2H	8	5	8.06
----------	---	---	---	------



EZ Clothes Line

• Suction cups and hooks for easy hookups • 15 feet of line • Locking tab keeps line taut

E12-7500VP	EZ Clothes Line, Carded	24/96	6/23	4.77
------------	-------------------------	-------	------	------



Stuff & Store

E12-7800	Stuff & Store Hanging Hamper	20	13	13.52
----------	------------------------------	----	----	-------



The Water Hole

The WATER HOLE eliminates water spills when traveling with your pet. Also keeps dog's ears dry when drinking. Top of dish extends inside bowl keeping bowl contents from spilling while vehicle is moving. Two-piece construction. Top removes for easy cleaning.

A72	Spill-Proof Pet Dish	12	7	7.60
-----	----------------------	----	---	------

Part No.	Ctn.Qty.	Ctn.Wt.	Retail Price
<ul style="list-style-type: none"> • Stainless steel • Panic Proof • Rekeyable • Fits Doors 1-3/8"-1-5/8"Thickness 			

Entrance Lock, 4 Way Universal



L32CS000	Knob x Lever Fits 2-3/8 " or 2-3/4 " backset, Standard or Drive-in Style Latches - Viewpack Stainless Steel	10	14	17.38
L32CS400	Lever Replacement for Entrance Door Lock	1/50	20	9.88

Entrance Lock, 4 Way Universal



L32CS010	Knob x Knob Fits 2-3/8 " or 2-3/4 backset, Standard or Drive-in Style Latches - Viewpack	10	16	18.13
----------	--	----	----	-------

Mobile Home Entrance Lock



Carton quantity includes 40 individually keyed locks and 1 master key.

L32BP010	Knob x Knob Fits 2-3/8 " or 2-3/4 backset, Standard or Drive-in Style Latches - Boxpack	40	59	20.25
L32PB095	Master Key	1	-	1.25

Privacy Lock for Bathroom & Bedroom Doors



Turn button to lock. Inside knob always free for exit. Outside knob can be unlocked by using a coin or screwdriver.

L32CS100	Privacy Bathroom/Bedroom lock 2 7/8" backset, Fits Standard or Drive-in Style Latches, Viewpack	10	14	14.08
----------	---	----	----	-------

Passage Lock for Interior Hall/Closet Doors



For interior doors and closets where locking is not required. Turning inside or outside knob retracts latch.

L32CS200	Passage lock 2-3/8 " backset, Fits Standard or Drive-in Style Latches, Viewpack	10	13	13.43
----------	---	----	----	-------



DEADBOLTS, LATCHES, & REPLACEMENTS

Part No.	Ctn.Qty.	Ctn.Wt.	Retail Price
----------	----------	---------	--------------

- Fits 2³/₈" backset
- Standard or Drive-in Style Latches
- Fits Doors 1³/₈" - 1⁵/₈" Thickness
- Stainless Steel



Single Cylinder Deadbolts

L32CS3008	5/8" Throw, Viewpack	10	11	19.50
L32CS3108	1" Throw, Viewpack	10	11	19.50



Double Cylinder Deadbolt

Fits 2³/₈" backset, Standard or Drive-in Style Latches

L32CS3208	5/8" Throw, Viewpack	10	13	26.43
-----------	----------------------	----	----	-------



4 Way Universal Replacement Latch for Entrance Door Locks

Fits 2³/₈", 2³/₄" backset, Standard or Drive-in Style Latches - Replacement for Valterra & EZ Set locks

L32VP050	4 Way Universal Latch	1	-	7.38
----------	-----------------------	---	---	------



Replacement Deadbolt Latches for Valterra & EZ Set

L32080-8	Standard/Drive in 2 ³ / ₈ "	1	-	9.58
L32080-4	Standard/Drive in 2 ³ / ₄ "	1	-	9.58



Strike Plate/Blank Key

L32PB060	Strike Plate with Screws	1	-	.70
L32PB070	Blank Key	1	-	.70



Re-keying Kit

- Eliminates need for more than one key
- Simple procedure allows re-keying of Entrance sets & Deadbolts
- Works on Valterra 4 Way Universal Locks, Kwik Set, and Elixir

L32BP500	Rekeying Kit	1	2	62.50
----------	--------------	---	---	-------



LITERATURE REQUEST FORM



(Front) MO600

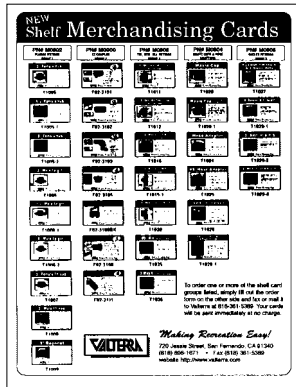

(Back)



(Front) MO602



(Back)



(Front) MO604



(Back)



(Front) MO606



(Back)



(Front) MO608



(Back)



(Front) MO610



(Front) MO612

Mail or Fax to Valterra

ORDER FORM



VALTERRA PRODUCTS, INC.
 15230 San Fernando Mission Blvd., Ste. 107
 Mission Hills, CA 91345
 Ph: 818-898-1671 • Fax: 818-361-5389
 www.valterra.com

Company Name _____

Address: _____

City: _____ State: _____ Zip: _____

Phone: _____ Fax: _____

Qty.	Part No.	Description
	M0600	Merchandising Cards (3" x 5") Order Form
	M0602	EZ Coupler Display Flyer
	M0604	Bladex/Cable Valve Flyer
	M0606	Merchandising Aides Order Form
	M0608	Water/Flushing Hose Flyer
	M0610	Teflon Tape Flyer
	M0612	Motor Homes/Trailers Made Easy Flyer



LIMITED ONE YEAR WARRANTY

Products sold by Valterra Products, Inc. are warranted free from defects in workmanship and materials for a period of one year from date of purchase. There are no other express warranties given.

During the above period, any defective part will be replaced at Valterra's expense upon receipt of written notice to Valterra of the defect claimed, together with your name, address, and telephone number. Send correspondence to Valterra Products, Inc., 15230 San Fernando Mission Blvd., Ste. 107, Mission Hills, CA 91345, phone (818) 898-1671.

The warranty applies when the product is used for the purpose intended, under normal conditions, and does not apply to damages caused by customer or by normal wear and tear. This warranty is void if the product has been damaged by accident, unreasonable use, neglect, or other causes not arising out of a defect of material or workmanship.

ANY IMPLIED WARRANTIES ARISING OUT OF THE SALE OF ANY PRODUCT, INCLUDING BUT NOT LIMITED TO THE IMPLIED WARRANTY OF MERCHANTABILITY AND FITNESS FOR A PARTICULAR PURPOSE, ARE LIMITED TO THE EXTENT AND DURATION OF THE EXPRESS WARRANTY HEREIN. MANUFACTURER SHALL NOT BE LIABLE FOR LOSS OF USE OF THIS PRODUCT OR OTHER INCIDENTAL OR CONSEQUENTIAL COSTS, EXPENSES, OR DAMAGES INCURRED BY THE CONSUMER OF ANY OTHER USER. THERE ARE NO WARRANTIES PROVIDED OTHER THAN AS STATED HEREIN.



VALTERRA PRODUCTS, INC.

15230 SAN FERNANDO MISSION BLVD., STE. 107 • Mission Hills, CA 91345

Phone: 818-898-1671 • Fax: 818-361-5389 • www.valterra.com





Making Recreation Easy!

AFTERMARKET
WDARV
ASSOCIATION
www.rvaftermarket.org
MEMBER

Member
RVIA
RECREATION VEHICLE
INDUSTRY ASSOCIATION

VALTERRA PRODUCTS, INC.

15230 San Fernando Mission Blvd., Ste. 107 • Mission Hills, CA 91345

Phone: 818-898-1671 • Fax: 818-361-5389 • www.valterra.com